



INSTALLATION INSTRUCTIONS

Arctic Fox In-Tank Fuel Warmer With Coolant By-Pass Thermostat

B-104—09/10

READ INSTRUCTIONS COMPLETELY BEFORE BEGINNING INSTALLATION

Models

C-406, C-407, C-456, C-457, CS-406, CS-407, CS-456, CS-457, F-407, F-456, F-457

IMPORTANT: The By-Pass Thermostat models differ from other Arctic Fox Warmers—read these instructions **COMPLETELY** before you begin the installation.

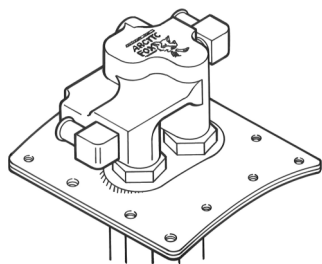

- **Warms fuel in tank and standpipe**
- **6 Inch (152mm) Square plate for solid mounting**
- **Warms close to standpipe**
- **Can be positioned in tank for easy hose alignment**
- **No electrical parts**
- **Bypass coolant at optimum operating temperature to stop heating in the tank**

IMPORTANT PRECAUTIONS

- Avoid mistakes. Read these instructions completely **before you begin**.
- Before you cut a hole in the fuel tank:
 - Know where all baffles are located.
 - Verify the swing radius of the fuel gauge arm.
 - Determine precisely where the plumbing lines will run.
- Check all parts against the parts listing on Page 4.

TOOLS NEEDED

- Needle-nose pliers or vise grip
- Two—Arctic Fox T-1781 Aligning Tools (optional)
- Center Punch and hammer
- Hack Saw
- Torque wrench (100 inch pound—11.3 nm)
- 1/2" Drive, 400 RPM drill with 5/16" and 1/8" drill bits
- T-520—3-3/4" hole saw and T-521 2" hole saw
- T-518—4-1/2" hole saw (If also installing a Model 50 Standpipe option).

IMPORTANT: READ BEFORE INSTALLATION

Check to be sure you have the correct Arctic Fox Warmer for the fuel tank. Models for flat top tanks should have a flat mounting plate, models for round tanks, 20" (508mm) in diameter and smaller should have black, curved mounting plates, and models for round tanks larger than 20" (508mm) diameter should have a chrome or gray mounting plate.

When installed in the fuel tank, clearance between the bottom of the fuel warmer and the bottom inside of tank must be 1" (25.4mm) minimum, and 2" (50.8mm) maximum. If the warmer has a fuel standpipe, the end of the standpipe should be 5/8" (16mm) minimum or 1" (25.4mm) maximum from the bottom inside of the tank. Obtain the clearances before cutting opening in tank by measuring length of heat exchange tube and fuel standpipe from bottom side of mounting plate and subtract those measurements from tank outside. See Fig. 1 WHERE TO MEASURE TANK. Also refer to Fig. 2 to calculate warmer's installed clearances within tank. Recheck dimensions after cutting opening by measuring inside tank and comparing with heater dimension.

WHERE TO MEASURE TANK

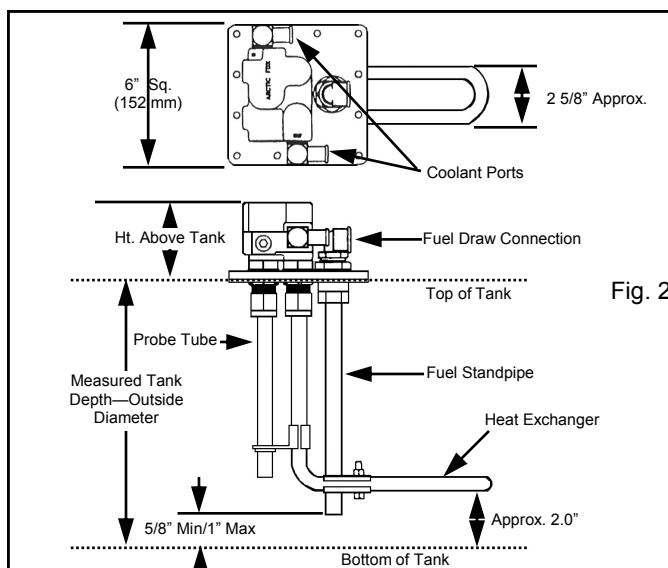
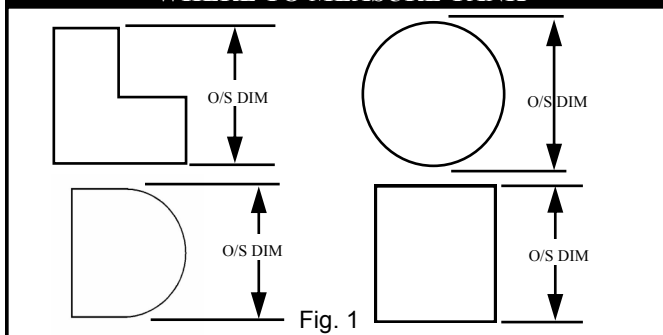

PREPARE THE TANK

- Determine which tank or tanks from which the engine draws its fuel, locate the fuel standpipe, fuel gauge sending unit, and all tank baffles. Determine a position for the heat exchange tubes where there will be no contact with **any** of these items. A minimum 1 inch (25mm) clearance is acceptable. For best results, locate the warmer very close to the fuel outlet. If this is not possible, the Arctic Fox Model 50 Standpipe Option is available to insure maximum efficiency. If the Model 50 Standpipe Option is used, locate the warmer as close as possible to the center of the tank.
- The kit includes a template which will be placed on the fuel tank top help you to punch and drill the mounting holes accurately.

OPTION: For multiple tank installations, you can purchase steel, drill template kits: KT-1916 Kit: for tanks 21" to 29" (533mm to 736mm) in diameter. KT-1917 Kit: for tanks up to 20" (508mm) in diameter. KT-1918 Kit: for flat top tanks.

IMPORTANT: Remove all grease and foreign material from the area where the warmer will be installed. Also determine which direction you are going to run the hoses to plumb the warmer to the engine.

After the mounting area has been cleaned, remove the paper backing from the template and affix it to the tank in the appropriate position. Note the arrow which points toward the engine.

- Using the template as a guide, center-punch the 12 outside holes and the 3 3/4" center hole and the 2" hole to the rear (away from the truck engine). If you are also installing a Model 50 Standpipe Option, center-punch the 2" hole to the front (toward the engine) for it as well.

CUT THE MOUNTING HOLES

- Exact hole location is very important, so we recommend that you carefully pre-drill each hole location with a 1/8" drill bit.
- Then use a 5/16" drill bit to drill the 12 outside holes to size. **NOTE:** In the following steps, you can keep most of the saw cuttings out of the tank if you apply a coating of grease on the inside and outside edge of the hole saw blade.
- If you are installing a Model 50 Standpipe Option use a 2" hole saw to cut the appropriate hole for it. **OPTION:** Instead of drilling a separate 2" hole for the Standpipe Option, you can use a 4 1/2" hole saw in step 7 below to make an opening that will accommodate both the warmer and the Standpipe.
- Use a 3 3/4" hole saw to cut the large hole for the warmer.
- Deburr each hole on the inside of the tank.
- Remove the template from the tank. Be sure to retrieve any portion of the template and round paper disk cut by the hole saw if either fell into the tank.

INSTALL THE BACKING PLATES

- Insert the backing plates (as shown in Fig. 3) inside the fuel tank, so they are parallel with the length of the tank. You can hold the backing plates in place with a needle nose pliers or vise grip.

Install two clips (#1) as shown in Fig. 1 to hold each backing plate in position (so they don't fall into the tank).

OPTION: You can also purchase two T-1781 aligning tools from Arctic Fox. They allow you to more easily line up the backing plates before installing the clips.

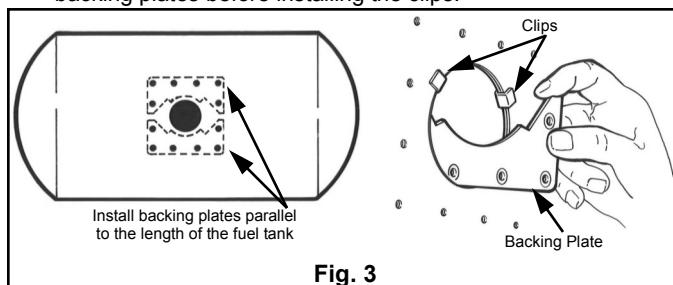

Fig. 3

INSTALL THE WARMER INTO THE TANK

- Lay the gasket over the opening in the tank.
- Insert the heater into the tank, and make sure it will **not come into contact with anything else inside the tank**—such as the standpipe, fuel gauge, tank baffles, or the tank itself.
- Insert and tighten all of the plate bolts to 40—60 in. lbs. (4.5—6.8 nm) of torque, or until all the bolts are snug to the top of the plate surface. Then tighten all the bolts to 78—95 in. lbs. (8.8—10.2 nm). Then recheck the bolts in the sequence indicated in Fig. 4 for 78—95 in. lbs. (8.8—10.2 nm).

IMPORTANT: To insure that the gasket seals properly, the above torquing procedure **MUST** be followed.

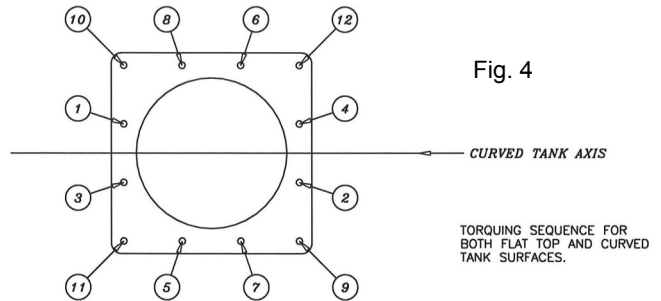

Fig. 4

CONNECT THE COOLANT SUPPLY HOSES

NOTE: Arctic Fox Insultube is available to insulate your fuel and coolant lines. It will minimize temperature drop between the engine and the fuel tank, and protect the heater hose from chafing.

IMPORTANT: In the following procedure, keep all hoses as straight and short as possible.

- Using heater hose (silicone hose preferred), plumb the water lines to the warmer according to the engine manufacturer's recommendations. See notes under "COOLANT SUPPLY" and "COOLANT RETURN" if unsure of engine manufacturers recommendation. The thermostat body on the warmer has the inlet and outlet marked (IN and OUT)
- Fasten all hoses securely.
- If the warmer has the Model 50 Standpipe Option, connect the fuel supply line to the standpipe with appropriate adapters. The standpipe has 1/2" NPT female pipe threads. Plug the original fuel supply fitting as necessary.

IMPORTANT NOTES

COOLANT SUPPLY

Obtain hot coolant from a pipe plug opening on the engine pressure side of the cooling system. Route coolant to the "IN" coolant port on the Warmer. In and out ports are marked on the thermostat casting.

COOLANT RETURN

Route coolant from the "OUT" coolant port on the warmer to an engine pipe plug on the suction side of the engine cooling system's water pump.

SUGGESTION: If you aren't sure which pipe plug ports on the engine are the coolant supply and return, locate the hose connections for the cab heater and plumb into ports in those same cavities.

TEES AND WYES ON COOLANT LINES

For most efficient warmer operation, install a separate coolant loop directly to and from the engine. Avoid using Tee or Wye fittings in the coolant supply and return lines, if at all possible (thereby paralleling with another accessory). However, if all engine access ports are being used for other accessories (such as cab/sleeper heaters, temperature sensors, etc.) you may have to consider a Tee or Wye as an option.

Any Tee or Wye used MUST be at least 1/2" NPT or larger. Tees and Wyes should be inserted into existing hoses as shown in Fig. 5, so that they provide the least restriction of coolant flow to the warmer.

Note also that plumbing a fuel warmer in series with a cab heater may drastically reduce the amount of heat transferred to the fuel.

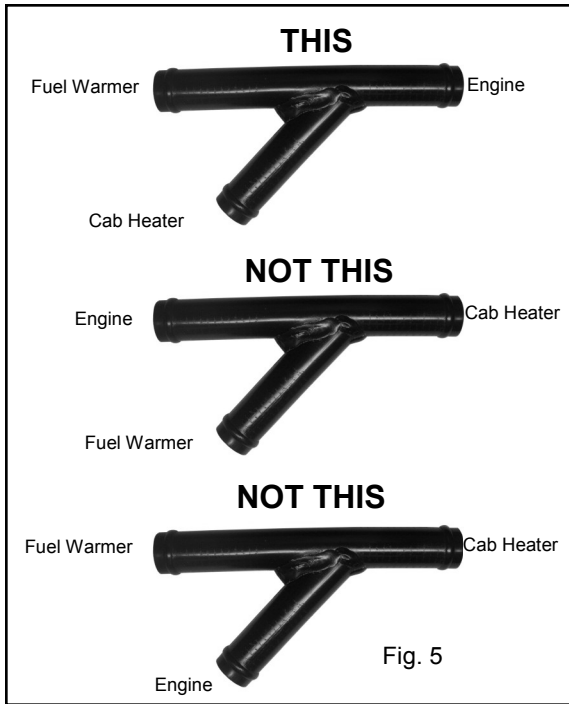

USING ADDITIONAL WARMERS

If an in-line fuel warmer or heated fuel/water separator is used along with the Fuel Tank Warmer, they can be plumbed in series in the same coolant loop. However, the hot coolant from the engine should first pass through the in-line warmer, then on to the Fuel Tank Warmer. This allows maximum anti-waxing protection for the primary fuel filter on initial startup after an extended "cold soak" period.

OPERATION CHARACTERISTICS

In normal operation, the By-Pass Thermostat on the Arctic Fox Fuel Warmer will discontinue the warming cycle automatically when fuel in the tank reaches approximately +80°F (+27°C). This feature eliminates the need to manually shut off coolant supply valves during warm weather operation. However, it may be a desirable practice to equip the engine with coolant supply and return shut-off valves in the Fuel Warmer coolant loop to allow servicing of the system without draining the entire cooling system.

It should be noted that, by design, the By-Pass Thermostat Warmer will discontinue routing hot coolant through the in-tank heat exchanger when fuel in the tank reaches optimum operating temperature. When this occurs, the hot coolant is directed through a by-pass circuit within the thermostat head and then directly back to the engine. Therefore, it is normal for the head of the Arctic Fox By-Pass Thermostat Warmer to be hot from coolant even in warm ambient conditions.

FIVE-YEAR OR 600,000-MILE WARRANTY

THIS WARRANTY IS EXPRESSLY LIMITED TO PERSONS WHO PURCHASE ARCTIC FOX FUEL TANK WARMERS

Arctic Fox Fuel Tank Warmers are warranted against defects in materials and workmanship for a period of five years or 600,000 miles from date of purchase by the user. This warranty does not cover fuel warmers which are altered or used for a purpose other than that for which they were intended or used in a manner inconsistent with any instructions regarding their use. The exclusive remedy for any unit found to be defective under this warranty is limited to the repair or replacement of the defective unit without charge, and **Arctic Fox shall NOT be liable for any consequential or incidental damages, including labor charges.** In order to qualify for this warranty, the alleged defective unit must be returned directly to the Arctic Fox factory postage or freight prepaid, and Arctic Fox will return the repaired or replaced unit postage or freight prepaid. Final determination of defects shall be made by Arctic Fox in accordance with procedures established by Arctic Fox. No agent, employee, or representative of Arctic Fox has any authority to bind any affirmation, representation or warranty concerning Arctic Fox products except as stated herein.

THERE ARE NO WARRANTIES WHICH EXTEND BEYOND THE DESCRIPTION OF THE EXPRESS NON-CONSUMER PRODUCT WARRANTY AS STATED ABOVE. THE ABOVE WARRANTY IS IN LIEU OF ANY OTHER WARRANTY, EXPRESS OR IMPLIED, AND EXPRESSLY EXCLUDES ANY WARRANTY OF MERCHANTABILITY OR FITNESS FOR A PARTICULAR PURPOSE.

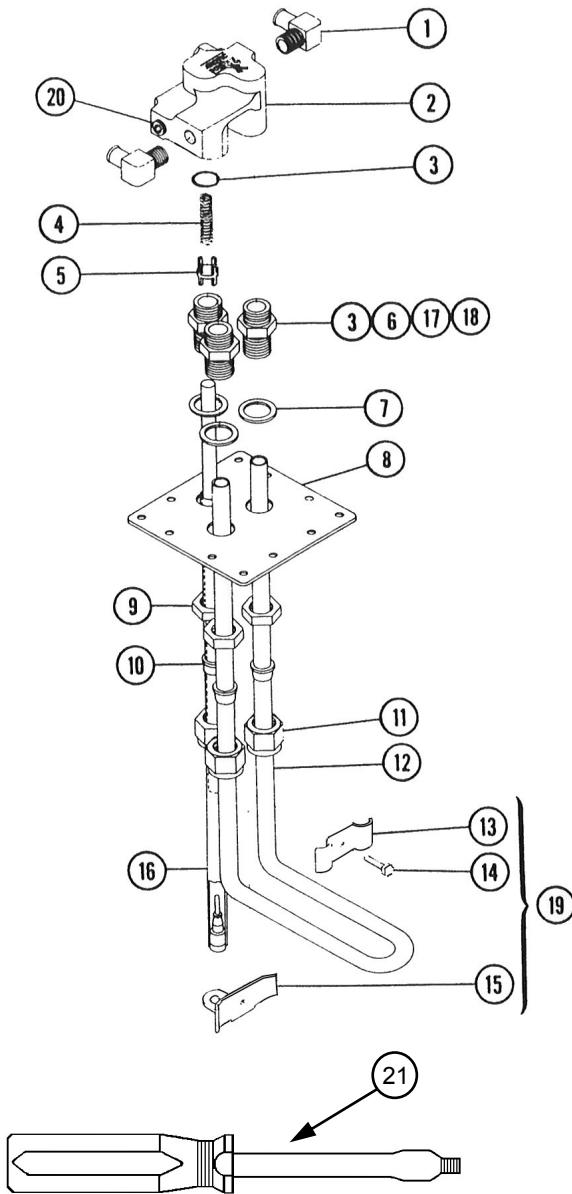

PARTS LIST		
Fuel Tank Warmer		
ITEM	PART NUMBER	DESCRIPTION
1	A-631 A-653	Elbow, 5/8" (16mm) hose barb to 1/2" male pipe (Qty.2) Elbow, 3/4" (19mm) hose barb to 1/2" male pipe (Qty.2)
2	A-400	Housing, thermostat
3	A-412	O-ring, housing
4	A-409	Spring
5	A-408	Plunger
6	A-401	Bushing (Qty. 3)
7	A-616	Washer, copper (Qty. 3)
8	A-414-3 A-414-3	Plate, flat, (Flat tanks) Plate, curved (Round tanks)
9	A-628	Nut, locking (qty. 3)
10	A-621	Ferrule, split ring (pkg. Of 4)
11	A-639	Nut, compression (Qty. 3)
12	A-600	Tubing, heat exchanger, 28" (711mm)
13	A-641	Clip, tube
14	A-253	Bolt, 1/4" UNC x 1"
15	A-659	Bracket, probe tube
16	N/A	Tube kit, Probe
17	A-617	O-ring kit (pkg. Of 4 white & 4 black)
18	KT-1913	O-ring kit (pkg. Of 4 external bushing)
19	A-646	Tube clip support kit
20	A-413	Plug, pipe (Qty. 4)
21	T-781	Tool, backing plate alignment (optional)
22	A-611	Gasket (not shown)
23	A-1795	Plate, backup, curved (Qty. 2—(not shown))
24	A-2025	Plate, backup, flat (Qty. 2 (not shown))
25	A-649	Clip, backing plate retainer (Qty. 4 (not shown))

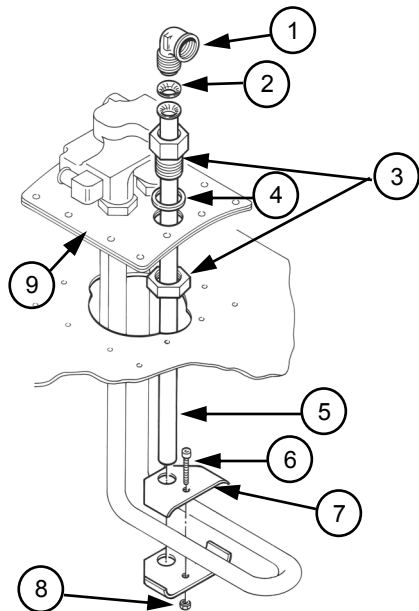

PARTS LIST		
Model 50 Standpipe Option		
ITEM	PART NUMBER	DESCRIPTION
1	A-609	Elbow, female, #10 flare x 1/2" NPT
2	A-635	Gasket, #10 inverted flare
3	A-622	Fitting, standpipe (3 parts)
4	A-616	Washer, copper
5	A-624	Standpipe
6	A-632	Bolt, 1/4" UNC x 1 1/4"
7	A-623	Clip, standpipe
8	A-633	Nut, nylon stop, 1 1/4" UNC
9	A-414-4 A-415-4	Plate, 4-hole flat Plate, 4-hole curved